

THE BOOK COVER CO.

2018
Catalogue

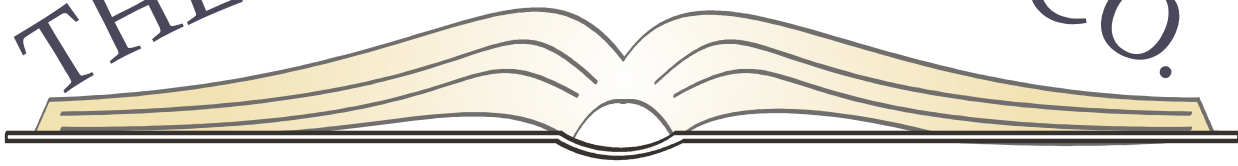

A family owned manufacturer of quality library supplies since 2001

Your friendly local supplier of:

Book Covering Products

Adhesive Printer Labels

Laminating film & laminator service

Adhesive tapes

Security tags

Many more related products

Ph : 03 9873 4629 Fax : 03 9872 4327
6 Azalea Street, Vermont, Vic 3133
www.bookcoverco.com.au





Welcome to The Book Cover Co

The Book Cover Co is a family owned, Australian business, specialising in the manufacture and supply of quality library supplies and associated products. These include book covering materials, adhesive tapes, printer labels, laminating film and other items.

We began in 2000, with a small range of products, and have continued to improve the quality of products on offer as well as increase the range of goods we have. Taking pride in quality and innovation, we strive to supply the best quality materials on the market at competitive rates, with fast and friendly service.

We're always happy to hear from you, and we'll be happy to help with any questions you may have. If you're looking for a related product or service which we don't offer, we may be able to help you locate it.

We'd love the chance to become your local supplier. All orders are guaranteed to meet your satisfaction, or they can be replaced or refunded.

We look forward to hearing from you

Tom & The Team at The Book Cover Co.

Risk Free Ordering ◦ **No Minimum Order** ◦ **Fast & Friendly Service**
Order online, by phone, fax, email or in person.

Introduction / Comparing prices	1	
Retail price List	2	
Adhesive Coverings	3	
Laminating Film	4	
Non Adhesive Coverings	5	
Unifold	Slip on Covers	6
Adhesive Labels	7	
Adhesive Tape	9	
Cutting Mats	Security Tags	10
Guide to choosing the right cover	11	



6 Azalea St, Vermont, Victoria 3133

Ph : 03 9873 4629 Fax : 03 9872 4327

email : info@bookcoverco.com.au

www.bookcoverco.com.au

Quick Guide

Quick guide to our book covering products

Adhesive Covers

Plascote	Self Adhesive covering film, standard thicknesses.
Flexicote	Super thick semi rigid film, supplied in sheets.

Non Adhesive Covers

Centurion	Durable 100 micron PVC film, gloss or matt finish.
Unifold	Dust jacket sleeving in PVC or Polypropylene.
Profold	Archival Polypropylene film.
Slip On Covers	Pre-made covers to suit most sizes of book.

*If you're not sure which product you need, a guide for choosing the right covering is on **Page 11**.*

Comparing Prices

When comparing prices of book covering rolls from different suppliers, there are some factors that need to be considered to get an accurate comparison. Due to the variety of widths, lengths and grades of covering material on the market, it is easy to make an inaccurate comparison between two products. What may seem like a saving at first may actually be dearer.

Roll Length

Many lengths of roll are advertised, these include 5M, 15M, 20M, 22.5M and 50M. Be sure to compare rolls of the same length, or calculate price per meter for rolls of the same width.

Roll width?

Make sure the rolls are the same width, confusion can be found when rolls are measured in CM, MM, and sometimes inches.

GST Inclusive?

Although all listed prices are meant to have GST, we have encountered book covering advertised without GST included, which gives a false impression of a lower price.

Thickness of plastic?

Much of the cost of self adhesive covering is in the clear plastic film. A variety of thicknesses are available, and it is important to compare covering of the same thickness to get a true idea of the comparative prices as a thin grade of plastic will be cheaper per roll but may not be of the quality you require.

Crunching the numbers

In this example, the 15M roll is \$3 cheaper per roll, but \$0.15 per meter more expensive.

Roll Dimensions	Price	Price ÷ Length = Price per meter
300mm x 15M	\$18.50 =	\$18.50 ÷ 15 = \$1.23
300mm x 20M	\$21.50 =	\$21.50 ÷ 20 = \$1.08

Retail Price List

Prices current as of April 2018
All prices shown include GST

Plascote 90 - Self adhesive covering

Delayed Bond - Satin or Gloss	20 Meter	50 Meter
Plascote 90 micron - 75mm	\$ 7.30	\$ 17.50
Plascote 90 micron - 225mm	\$21.95	\$ 52.50
Plascote 90 micron - 250mm	\$24.50	\$ 57.00
Plascote 90 micron - 280mm	\$26.50	\$ 63.00
Plascote 90 micron - 300mm	\$29.25	\$ 69.50
Plascote 90 micron - 330mm	\$31.50	\$ 75.95
Plascote 90 micron - 380mm	\$36.50	\$ 87.50
Plascote 90 micron - 450mm	\$42.50	\$100.50
Plascote 90 micron - 600mm	\$55.25	\$131.50
Plascote 90 micron - 900mm	\$78.75	\$186.75

Plascote 110- Self adhesive covering

Delayed Bond - Gloss	20 Meter	50 Meter
Plascote 110 micron - 75mm	\$ 8.50	\$ 19.75
Plascote 110 micron - 225mm	\$24.20	\$ 58.00
Plascote 110 micron - 250mm	\$26.50	\$ 63.60
Plascote 110 micron - 280mm	\$29.25	\$ 66.50
Plascote 110 micron - 300mm	\$32.25	\$ 77.65
Plascote 110 micron - 330mm	\$35.50	\$ 85.00
Plascote 110 micron - 380mm	\$40.50	\$ 96.75
Plascote 110 micron - 450mm	\$46.70	\$111.50
Plascote 110 micron - 600mm	\$60.50	\$145.50
Plascote 110 micron - 900mm	\$86.75	\$208.26

Unifold Dust Jacket Sleeving (PVC)

PVC Clear Gloss or Matt finish	25 Meter	50 Meter
Unifold PVC - 200mm	\$26.50	\$ 51.25
Unifold PVC - 230mm	\$32.00	\$ 61.50
Unifold PVC - 250mm	\$34.90	\$ 68.00
Unifold PVC - 270mm	\$37.40	\$ 72.25
Unifold PVC - 300mm	\$41.70	\$ 80.75
Unifold PVC - 330mm	\$46.60	\$ 90.30
Unifold PVC - 380mm	\$49.75	\$ 96.30
Unifold PVC - 420mm	\$60.00	\$116.75

Unifold Dust Jacket Sleeving (PP)

Gloss Acid Free Polypropylene	25 Meter	50 Meter
Unifold PVC - 200mm	\$30.65	\$ 60.65
Unifold PVC - 230mm	\$37.00	\$ 72.45
Unifold PVC - 250mm	\$40.60	\$ 80.45
Unifold PVC - 270mm	\$43.45	\$ 85.40
Unifold PVC - 300mm	\$48.40	\$ 95.35
Unifold PVC - 330mm	\$54.10	\$106.70
Unifold PVC - 380mm	\$58.85	\$113.85
Unifold PVC - 420mm	\$69.95	\$138.05

Flexicote 250 micron sheets

Semi rigid cover	10 pack	100 pack
Size 1 - 150mm x 220mm	\$1.35	\$12.75
Size 2 - 210mm x 297mm	\$1.70	\$15.80
Size 3 - 240mm x 315mm	\$2.25	\$21.00
Size 4 - 297mm x 420mm	\$2.55	\$23.00

Centurion - Non adhesive PVC film

100 micron thickness - Non Stick			
Gloss / Matt finish	25 Meter	50 Meter	100 Meter
Centurion - 235mm	\$20.50	\$ 35.00	\$ 69.00
Centurion - 300mm	\$25.75	\$ 44.50	\$ 87.50
Centurion - 350mm	\$28.00	\$ 47.50	\$ 92.00
Centurion - 400mm	\$30.50	\$ 54.00	\$105.00
Centurion - 450mm	\$32.00	\$ 56.50	\$110.00
Centurion - 600mm	\$38.00	\$ 67.50	\$132.00
Centurion - 900mm	\$57.50	\$100.00	\$195.50

Pro-Lene - Acid Free Non adhesive

90 Micron thickness	25 Meter	50 Meter	100 Meter
Pro-Lene - 235mm	\$21.95	\$ 41.65	\$ 81.00
Pro-Lene - 300mm	\$27.00	\$ 52.35	\$102.60
Pro-Lene - 350mm	\$29.85	\$ 55.25	\$108.00
Pro-Lene - 400mm	\$32.65	\$ 63.00	\$124.20
Pro-Lene - 450mm	\$33.75	\$ 65.85	\$129.60
Pro-Lene - 600mm	\$40.50	\$ 83.00	\$151.90
Pro-Lene - 900mm	\$60.20	\$116.50	\$225.00

Slip-On Covers

200 micron PVC	1-9 pcs	10 pack	100 Pack
166mm - 204mm	\$1.35 ea.	\$12.75	\$ 94.00
206mm - 230mm	\$1.70 ea.	\$15.80	\$115.00
232mm - 270mm	\$2.25 ea.	\$21.00	\$155.00
272mm - 294mm	\$2.55 ea.	\$23.00	\$170.00
296mm - 316mm	\$3.00 ea.	\$26.00	\$195.00

Adhesive Tape

Clear Attaching Tape 66M - 12mm	\$ 1.60
Clear Attaching Tape 66M - 12mm	\$ 2.00
Clear Attaching Tape 66M - 12mm	\$ 4.00
Clear Spine Tape 50M - 36mm	\$ 4.50
Clear Spine Tape 50M - 48mm	\$ 6.00
Clear Spine Tape 50M - 72mm	\$ 9.00
Clear Spine Tape 50M - 96mm	\$12.00
Matt finish mending tape 66M - 12mm	\$ 4.50
Matt finish mending tape 66M - 19mm	\$ 6.20
Matt finish mending tape 66M - 24mm	\$ 6.75
White Vinyl Hinge Tape - 50M - 19mm	\$ 2.75
White Vinyl Hinge Tape - 50M - 25mm	\$ 3.40
White Vinyl Hinge Tape - 50M - 50mm	\$ 6.50
Cloth binding tape - 25M - 36mm	\$10.00
Cloth binding tape - 25M - 36mm	\$12.00
Cloth binding tape - 25M - 36mm	\$19.00
Cloth binding tape - 25M - 36mm	\$24.00

A4 Printer Labels

19mm x 19mm - 8 sheets (1000 labels)	\$ 14.25
19mm x 19mm - 100 sheets (12600 labels)	\$155.00
19mm x 24mm - 12 sheets (1020 labels)	\$ 16.75
19mm x 24mm - 100 sheets (9000 labels)	\$114.00
24mm x 32mm - 14 sheets (1008 labels)	\$ 20.85
24mm x 32mm - 100 sheets (7200 labels)	\$125.00

[See Product page for more labels and product details](#)

Security Tags

EAS Book Strips - Single Sided - 1000	\$250.00
EAS Book Strips - Double Sided - 1000	\$260.00
CD / DVD Security Tag - Single Strip - 100	\$185.00
CD / DVD Security Tag - Double Strip - 100	\$195.00

Clear Overlay Labels

70mm x 35mm - 4 sheets (96 labels)	\$ 14.25
70mm x 35mm - 42 sheets (1008 labels)	\$ 69.50
70mm x 35mm - 100 sheets (2400 labels)	\$145.00
70mm x 70mm - 8 sheets (96 labels)	\$ 22.00
70mm x 70mm - 84 sheets (1008 labels)	\$115.00
70mm x 70mm -100 sheets (1200 labels)	\$145.00

Adhesive Coverings

Plascote Self Adhesive Book Covering

Plascote self adhesive book covering film is a commonly used form of permanent covering. It protects, reinforces and enhances your books, greatly improving their durability.

Delayed Bond adhesive gives you time to smooth out wrinkles and remove bubbles before the film bonds permanently to the book, allowing you to achieve a perfect result every time.

A wide range of sizes are available, from 75mm to 900mm. Using a roll close to the size of your book prevents wastage, saving money and material.

Available in 90 or 110 micron thick film with a gloss finish, or 80 micron with a low sheen satin finish.



Plascote 90

Satin or Gloss finish	20 Meter	50 Meter
Plascote 90 - 75mm	\$ 7.30	\$ 17.50
Plascote 90 - 225mm	\$21.95	\$ 52.50
Plascote 90 - 250mm	\$24.50	\$ 57.00
Plascote 90 - 280mm	\$26.50	\$ 63.00
Plascote 90 - 300mm	\$29.25	\$ 69.50
Plascote 90 - 330mm	\$31.50	\$ 75.95
Plascote 90 - 380mm	\$36.50	\$ 87.50
Plascote 90 - 450mm	\$42.50	\$100.50
Plascote 90 - 600mm	\$55.25	\$131.50
Plascote 90 - 900mm	\$78.75	\$186.75

Plascote 110

Gloss finish	20 Meter	50 Meter
Plascote 110 - 75mm	\$ 8.50	\$ 19.75
Plascote 110 - 225mm	\$24.20	\$ 58.00
Plascote 110 - 250mm	\$26.50	\$ 63.60
Plascote 110 - 280mm	\$29.25	\$ 66.50
Plascote 110 - 300mm	\$32.25	\$ 77.65
Plascote 110 - 330mm	\$35.50	\$ 85.00
Plascote 110 - 380mm	\$40.50	\$ 96.75
Plascote 110 - 450mm	\$46.70	\$111.50
Plascote 110 - 600mm	\$60.50	\$145.50
Plascote 110 - 900mm	\$86.75	\$208.26

Flexicote 250 micron Semi rigid covering

Flexicote is a 250micron thick polyester adhesive film, designed to add rigidity to covers.

Application of Flexicote is quick and easy. Simply stick one sheet to the front, and one to the back of a book, then trim any excess. To finish the book, a strip of Plascote or similar self adhesive is often applied across the spine of the book. Flexicote can also be applied to the inside cover of a book to add rigidity.



Flexicote 250 micron sheets

Semi rigid cover	10 pack	100 pack
Size 1 - 150mm x 220mm	\$1.35	\$12.75
Size 2 - 210mm x 297mm	\$1.70	\$15.80
Size 3 - 240mm x 315mm	\$2.25	\$21.00
Size 4 - 297mm x 420mm	\$2.55	\$23.00

Laminating Film



Roll Laminating Film

Premium quality laminating film on rolls to suit a range of roll-fed laminating machines.

This film is designed to provide long lasting enhancement and protection to your laminated items without the problems that can occur with cheap films, such as wrinkling and poor adhesion.

Available in a range of widths, other sizes available, please call for availability and sizes.

Roll Laminating film - 80 micron
Price per roll (2 rolls required)

530mm x 100M	\$ 52.00
790mm x 100M	\$ 79.20
1020mm x 100M	\$ 99.50

*Are you uncertain about how to reload your laminator? Would you like some free training or a service of your laminator?
Contact us for more information.*

Pouch Laminating Film

Premium quality pouch laminating film for use with A4 and A3 pouch laminators. We can supply a wide range of sizes, to suit small cards up to A3.

Available in a range of sizes and thicknesses, many sizes are available. If you require a size we don't show here, please contact us.

All prices are for packets of 100 pouches.

80 micron pouches

A5	\$ 11.00
A4	\$ 18.50
A3	\$ 35.00

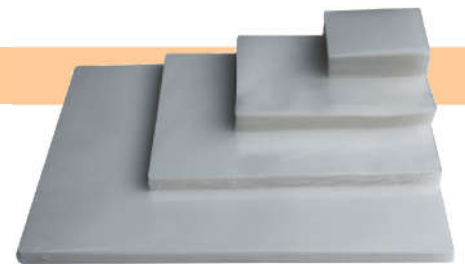

150 micron pouches

54 x 85	\$ 4.90
60 x 90	\$ 5.50
65 x 95	\$ 5.50
A5	\$19.50
A4	\$24.50
A3	\$55.00

Laminator Servicing / instruction sessions

We have decades of experience with a range of laminating machines, from small pouch laminators to large roll fed laminators.

If you have a technical problem with your laminator, please get in touch as we offer full servicing of many types.

If you have a roll fed laminator but are unsure how to use it, or need staff training, please contact us as we can provide on site training for you.

Non Adhesive Covers

Prices current as of August 2016.
All prices shown include GST

Non adhesive covers are designed to protect a book while remaining removable. In most applications there is no adhesive in direct contact with the book itself, which means a damaged cover may be replaced.

Centurion PVC Book Covering Film

Centurion covering is a range of high quality, 100 micron thick PVC book covering plastic. It is available in **Gloss** or **Matt** finish, and in a wide range of widths. Roll lengths are **25M, 50M** or **100M**.

Centurion is highly versatile as it can be used to cover hardcover and softcover books, as well as other general uses, for example as a protective film for surfaces or for crafts. Low odour and



- ✓ Non Adhesive
- ✓ Gloss & Matt
- ✓ Easy to use
- ✓ Removable
- ✓ High durability
- ✓ Enhances books
- ✓ Won't yellow with age
- ✓ Won't cause damage

Centurion - Non adhesive PVC film

100 micron thickness - Non Stick

Gloss / Matt finish	25 Meter	50 Meter	100 Meter
Centurion - 235mm	\$20.50	\$ 35.00	\$ 69.00
Centurion - 300mm	\$25.75	\$ 44.50	\$ 87.50
Centurion - 350mm	\$28.00	\$ 47.50	\$ 92.00
Centurion - 400mm	\$30.50	\$ 54.00	\$105.00
Centurion - 450mm	\$32.00	\$ 56.50	\$110.00
Centurion - 600mm	\$38.00	\$ 67.50	\$132.00
Centurion - 900mm	\$57.50	\$100.00	\$195.50

Pro-Lene Acid Free Book Covering Film

Pro-Lene is a crystal clear, non adhesive, acid free polypropylene film, which will enhance the appearance of your books while offering long lasting protection to your valued books.

Pro-Lene can be used to cover any type of book. It is highly resistant to handling damage, stains and shrinkage. It won't yellow with age, and can't stick to itself, preventing the problem of covered books binding to one another on the shelf.



Pro-Lene - Acid Free Non adhesive

90 Micron thickness	25 Meter	50 Meter	100 Meter
Pro-Lene - 235mm	\$21.95	\$ 41.65	\$ 81.00
Pro-Lene - 300mm	\$27.00	\$ 52.35	\$102.60
Pro-Lene - 350mm	\$29.85	\$ 55.25	\$108.00
Pro-Lene - 400mm	\$32.65	\$ 63.00	\$124.20
Pro-Lene - 450mm	\$33.75	\$ 65.85	\$129.60
Pro-Lene - 600mm	\$40.50	\$ 83.00	\$151.90
Pro-Lene - 900mm	\$60.20	\$116.50	\$225.00

Unifold Dust Jacket Sleeving

Unifold dust jacket sleeving is a highly durable and effective covering for hardcover books with dust jackets. Consisting of a plastic front and a paper backing, it forms a protective sleeve around the dust jacket and around the book ends, holding the cover securely in place. This style of book covering has been used for decades in libraries, bookshops and by private collectors.

Manufactured on our premises, we take the utmost care in providing a product we feel is second to none in quality. Your satisfaction with this product is guaranteed.



Unifold (PVC)

Gloss or Matt finish	25 Meter	50 Meter
Unifold PVC - 200mm	\$29.15	\$ 56.30
Unifold PVC - 230mm	\$35.20	\$ 67.65
Unifold PVC - 250mm	\$38.40	\$ 74.80
Unifold PVC - 270mm	\$41.15	\$ 79.45
Unifold PVC - 300mm	\$45.85	\$ 88.85
Unifold PVC - 330mm	\$51.25	\$ 99.30
Unifold PVC - 380mm	\$54.75	\$105.95
Unifold PVC - 420mm	\$66.00	\$128.40

Unifold (PP)

Gloss Polypropylene	25 Meter	50 Meter
Unifold PP - 200mm	\$30.65	\$ 60.65
Unifold PP - 230mm	\$37.00	\$ 72.45
Unifold PP - 250mm	\$40.60	\$ 80.45
Unifold PP - 270mm	\$43.45	\$ 85.40
Unifold PP - 300mm	\$48.40	\$ 95.35
Unifold PP - 330mm	\$54.10	\$106.70
Unifold PP - 380mm	\$58.85	\$113.85
Unifold PP - 420mm	\$69.95	\$138.05

Unifold Pro Dust Jacket Sleeving

Unifold Pro is the same as Unifold, however it includes a self adhesive strip which means that tape is not needed for covering. An easy to peel strip reveals a strong, permanent adhesive. Save time, save money on tape!

Upgrade to Unifold Pro

Cost per roll	25 Meter	50 Meter
Unifold Pro additional cost	\$ 2.65	\$ 4.40



Slip-On Covers Easy to fit PVC covers

These cleverly designed and durable book covers slip quickly onto a paperback book, offering protection and enhancing the appearance and durability of the book.

Made from a thick and glossy 200 micron PVC, these covers can be reused, and being adjustable suit a wide range of book thicknesses. Slip on covers are most commonly used for paperback books, but can also be used on hardback books.

The Book Cover co stocks the widest range of these slip on covers, so you're bound to find the cover which suits your needs. Available in 2mm increments from 166mm to 316mm.

Slip-On Covers

200 micron PVC	1-9 pcs	10 pack	100 Pack
166mm - 204mm	\$1.35 ea.	\$12.75	\$ 94.00
206mm - 230mm	\$1.70 ea.	\$15.80	\$115.00
232mm - 270mm	\$2.25 ea.	\$21.00	\$155.00
272mm - 294mm	\$2.55 ea.	\$23.00	\$170.00
296mm - 316mm	\$3.00 ea.	\$26.00	\$195.00

Labels (Actual Size)

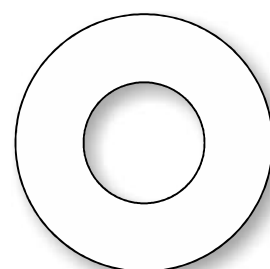
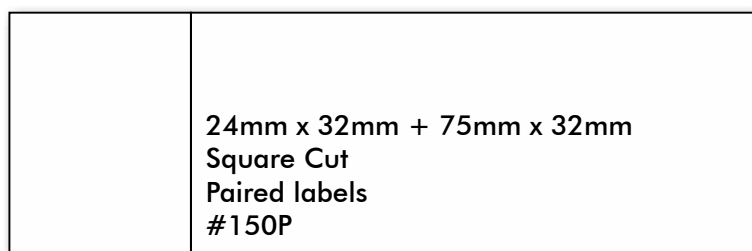
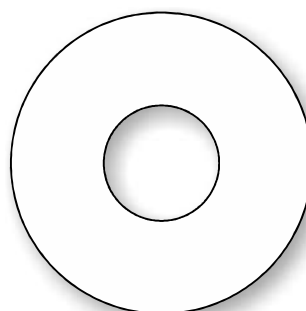
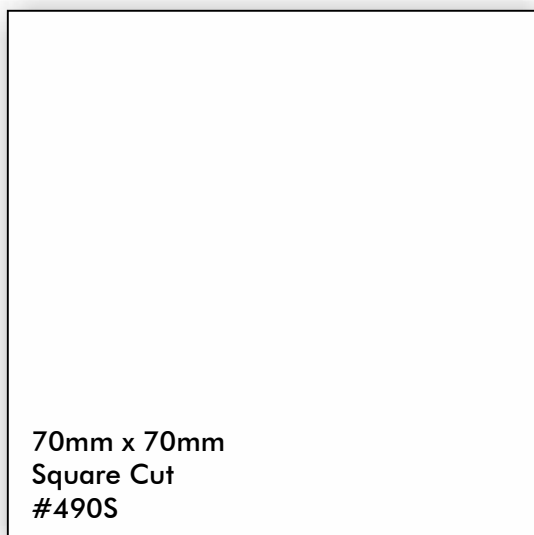
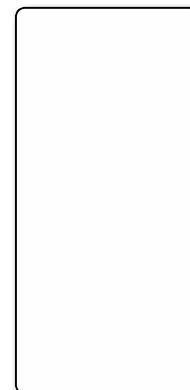
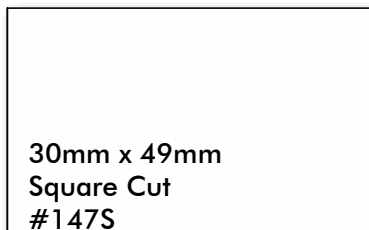
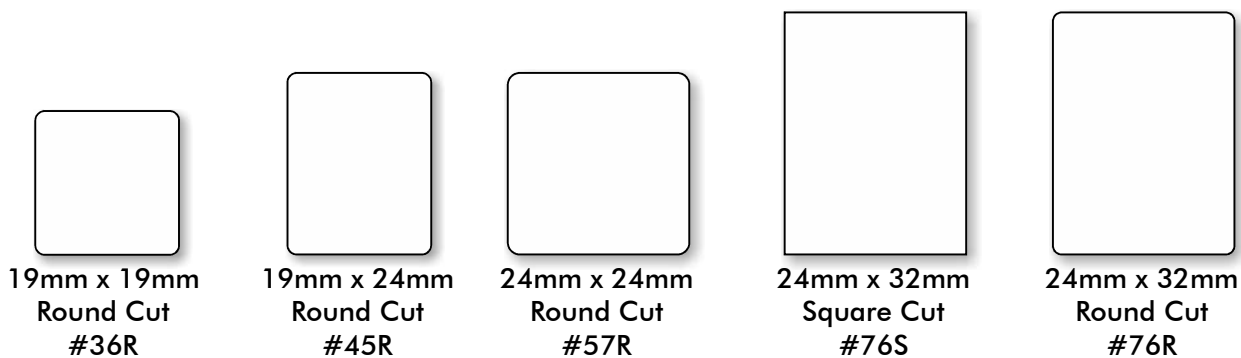

34mm / 16mm
'Donut' #D3416

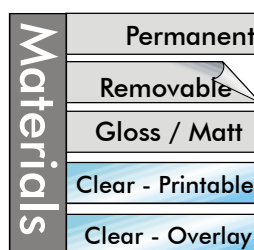
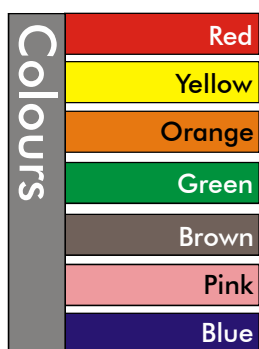
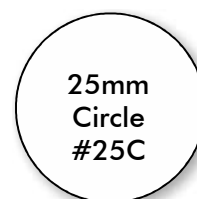

Colours shown may not exactly match actual label colours. Other colours & tints available. Minimum quantity may apply. Samples available on request.

A4 Sheet Adhesive Labels

Spine Labels - 19mm x 19mm - Round Cut

Inkjet / Laser printable
White matt finish paper
9 across, 14 down (126 per sheet)



8 Sheets (1008 labels)	\$ 14.25
100 sheets (12600 labels)	\$155.00

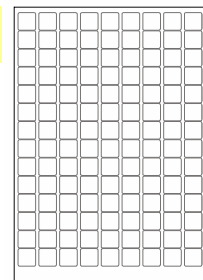

Spine Labels - 19mm x 24mm - Round Cut

Inkjet / Laser printable
White matt finish paper
9 across, 10 down (90 per sheet)



12 Sheets (1080 labels)	\$ 16.75
100 sheets (9000 labels)	\$114.00

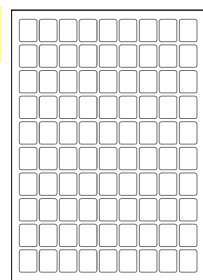

Spine Labels - 24mm x 24mm - Round Cut

Inkjet / Laser printable
White matt finish paper
7 across, 10 down (70 per sheet)



15 Sheets (1050 labels)	\$ 19.50
100 sheets (7000 labels)	\$115.00

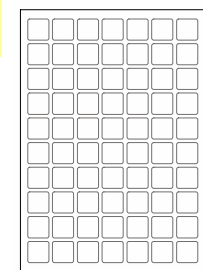

Spine Labels - 32mm x 24mm - Square Cut

Inkjet / Laser printable
White matt finish paper
8 across, 9 down (72 per sheet)

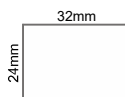

14 Sheets (1008 labels)	\$ 20.85
100 sheets (7200 labels)	\$125.00

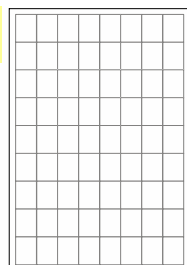

Clear Overlay Labels - 70mm x 35mm

Clear gloss PVC
Bar code protector / overlay label
3 across, 8 down (24 per sheet)



4 Sheets (96 labels)	\$ 12.50
42 Sheets (1008 labels)	\$ 69.50
100 sheets (2400 labels)	\$145.00

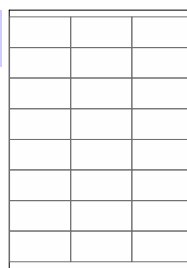

Clear Overlay Labels - 70mm x 70mm

Clear gloss PVC
Bar code protector / overlay label
3 across, 4 down (12 per sheet)



8 Sheets (96 labels)	\$ 22.00
84 Sheets (1008 labels)	\$ 115.00
100 sheets (1200 labels)	\$145.00

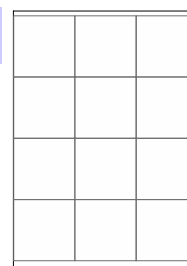

Other types and materials available, if you need a label not shown here, please contact us.

Adhesive Tape

Clear Attaching Tape

A strong and super clear Polypropylene tape that won't yellow with age. Low odour, acrylic adhesive.



12mm x 66M	\$1.60 ea.
19mm x 66M	\$2.00 ea.
24mm x 66M	\$2.40 ea.

Matt finish mending tape

Almost invisible on paper, this low sheen tape is recommended for mending damaged paper. Non yellowing, and can be written on.



12mm x 66M	\$4.50 ea.
19mm x 66M	\$5.20 ea.
24mm x 66M	\$6.75 ea.

Clear Spine Tape

Made from a thick and durable polypropylene tape, this high tack tape is available in a wide range of sizes and is perfect for binding, reinforcing, repair and book protection. Non yellowing, and



36mm x 50M	\$ 4.50 ea.
48mm x 50M	\$ 6.00 ea.
72mm x 50M	\$ 9.00 ea.
96mm x 50M	\$12.00 ea.

White Vinyl Book Tape

Commonly used for book repairs and reinforcing book hinges. Opaque white in colour.



19mm x 66M	\$2.75 ea.
25mm x 66M	\$3.40 ea.
50mm x 66M	\$6.50 ea.

Cloth binding tape

This rubberised cloth tape is perfect for binding and book repairs. It is not only very strong, but has a strong, long lasting adhesive. A wide range of colours is available

36mm x 25M	\$10.00 ea.
48mm x 25M	\$12.00 ea.
72mm x 25M	\$19.00 ea.
100mm x 25M	\$24.00 ea.



Self Healing Cutting Mats

Perfect for book covering, scrapbooking, dressmaking, arts & crafts and hobbies!

Self Healing Cutting Mats are an excellent way of protecting benchtops while cutting, and provide a cutting surface which allows more accurate work with a knife. A non slip base and surface helps to keep the item being cut steady. Grid marking and angle marking help with accuracy.



The self healing mat closes over the incisions made when cutting, and maintains a smooth work surface even after prolonged use.



Small (A3) 295mm x 450mm	\$ 15.50
Medium (A2) 450mm x 600mm	\$ 32.00
Large (A1) 600mm x 900mm	\$ 64.00

EAS Security Tags

Book / Magazine Security Tags

These security tags can be deactivated and reactivated with many security systems, and are fully compatible with a wide range of security systems including Tattletape™, Dialoc™ and Checkpoint™.

Double sided security tags are used in hardcover books, and are usually inserted into the spine of the book. Single sided security tags are best suited for paperback books, magazines and general article security purposes. Available in **Single** or **Double sided** adhesive.



Single Sided

Pack of 100	\$ 22.00
Box of 1000	\$115.00

Double Sided

Pack of 100	\$ 28.00
Box of 1000	\$260.00

CD / DVD security labels

One or Two security strips are incorporated into a clear protective label. When applied to the top of a CD or DVD, the label protects the disc against theft and physical damage. The label does not affect the usability of the disc, as the light weight of the strips does not cause the disc to go out of balance.



CD / DVD Security labels

Pack of 100

Single Strip	\$165.00
Double Strip	\$195.00

Which covering do I need?

Follow this flow chart to help decide what covering best meets your requirements.
If you're still unsure which product is right for you, please don't hesitate to contact us.

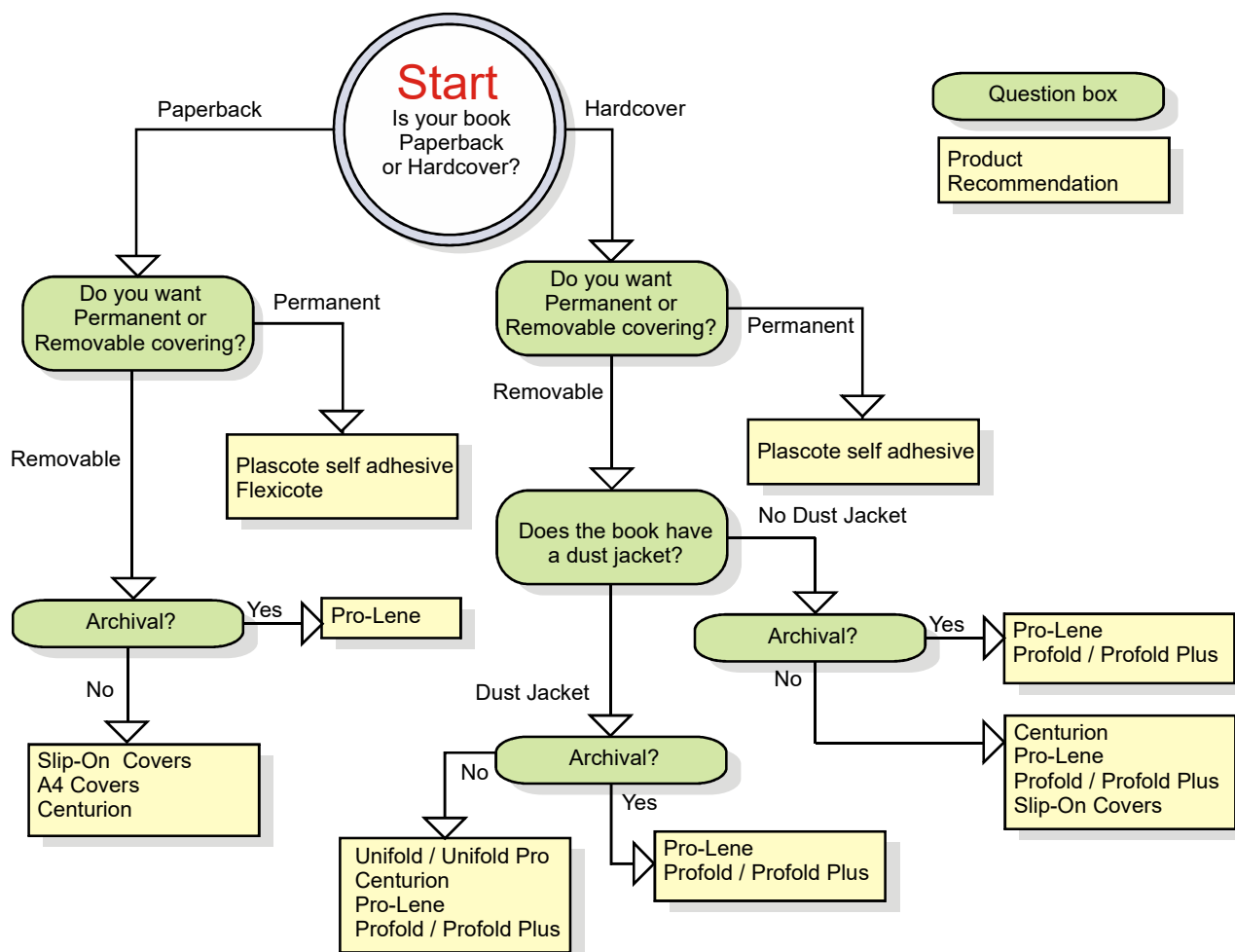

Definitions

Permanent / Non Permanent

A permanent cover can never be removed from a book. A non permanent cover offers good protection, but can be removed or replaced if damaged.

Archival

Archival plastics are acid free, and generally only used on very valuable or delicate books.

for more information, visit
www.bookcoverco.com.au

THE BOOK COVER CO.

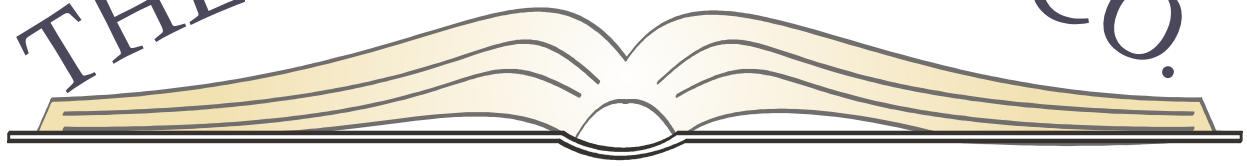

A family owned manufacturer of quality library supplies since 2001

Visit us online!

Product info,
Prices, Instructions and more

www.bookcoverco.com.au



Visit us in person.

Buy in store and save. Factory seconds and imperfect rolls available. We'll be happy to show you our product range.

6 Azalea Street, Vermont, 3133

(Near Brentford Square shops)

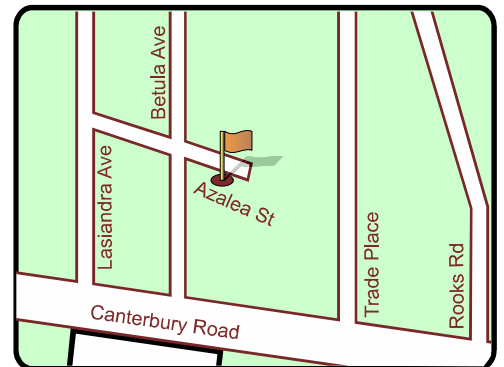

Call or Email.

Have a question? We're happy to help.

Phone 03 9873 4629

Email info@bookcoverco.com.au

